

EAD 16 vs. ETAG 013: technical modifications and lessons learned

Jürgen Schulz

Dr. Hermann Weiher

matrics engineering GmbH, Munich/Germany

18.04.2016, EAD 16-Seminar



Outline: EAD 16 vs. ETAG 013

- 1) Scope
- 2) Testing program / Series of sizes
- 3) Test details

EAD DP 14-16-0004-03.01 (Draft: 12.11.2015)
ETAG 013 (Edition: 2002)

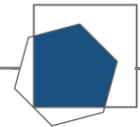

1) Scope - Content focus

Internal bonded and internal unbonded

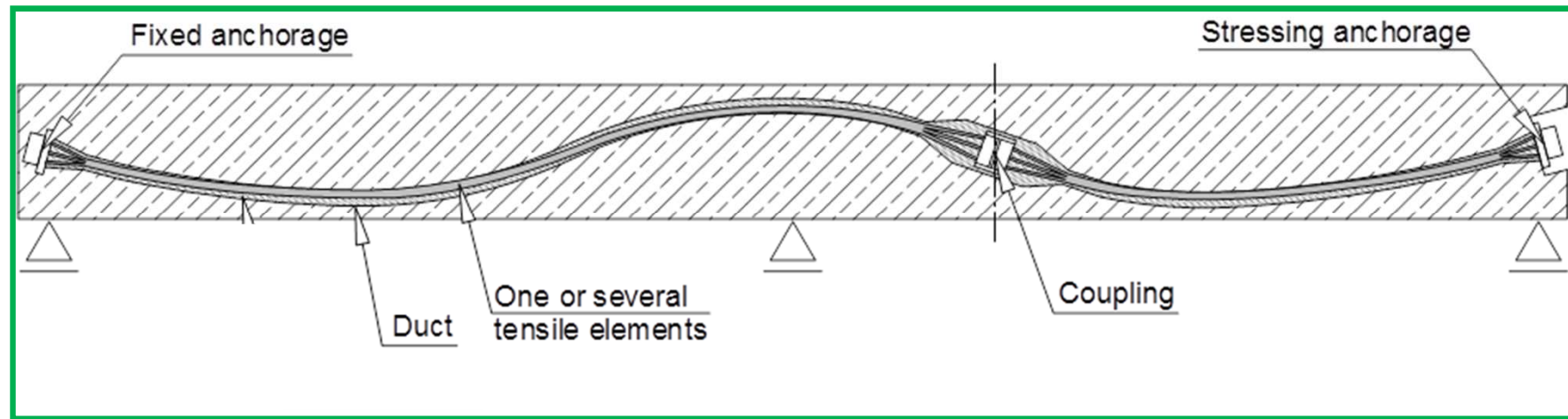

External unbonded

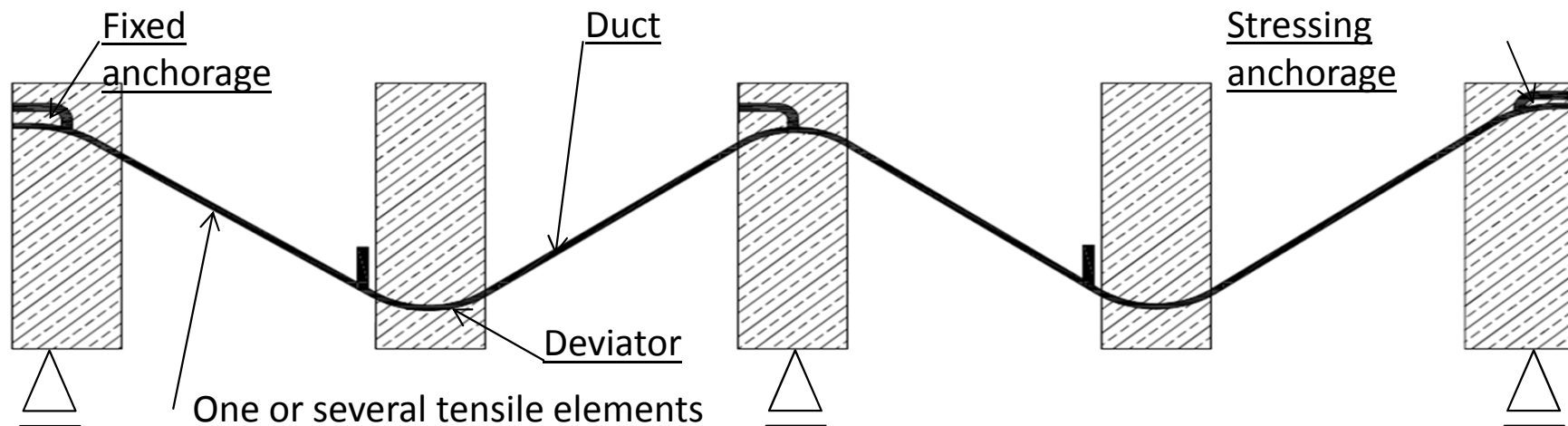

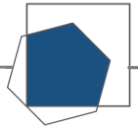

1) Scope - Testing focus

- Resistance to static load
- Resistance to fatigue
- Load transfer to structure
- Friction coefficient
- Deviation / Deflection
- Practicality / Reliability
- Resistance to static load under cryogenic conditions
- Material properties of plastic ducts (PL1, PL2 and PL3)
- Corrosion protection
- Monostrand, sheathing base material
- Monostrand manufactured sheathing
- Monostrand, manufactured monostrand

Draft EAD – European Assessment Document EAD-100094-00-0301, rev. yyyy adoptionfinal 19/107
EOTA file № 14-16-0064-03.01

3
Minimum centre distance of anchorage in the structure in y-direction, derived from reference dimensions a and b.

4
Edge distance in x-direction in the structure, derived from minimum centre distance x of anchorage in the structure

4
Edge distance in y-direction in the structure, derived from minimum centre distance y of anchorage in the structure

2 ESSENTIAL CHARACTERISTICS AND RELEVANT ASSESSMENT METHODS AND CRITERIA

2.1 Essential characteristics of the product

Table 1 shows how the performance of PT fits its assessed in relation to the essential characteristic.

Table 1 Essential characteristics of the product and methods and criteria for assessing the performance of the product in relation to those essential characteristics

No	Essential characteristic	Assessment method	Type of expression of product performance (level, class, description)
Basic Works Requirement 1: Mechanical resistance and stability			
1	Resistance to static load	Static load test (Annex C.1.1) Clause 2.2.1	Level
2	Resistance to fatigue	Fatigue test (Annex C.2) Clause 2.2.2	Level
3	Load transfer to structure	Load transfer test (C.3) Clause 2.2.3	Level
4	Friction coefficient	(1) Tension: - Assessment of - Assembly/ installation/ stressing test (Annex C.5.1) (2) Anchorage / coupling: - Assessment Clause 2.2.4	Level
6	Deviation/ deflection (level) for internal bonded and internal unbonded tendon	- Assessment Clause 2.2.5	Description

©EOTA yyyy
EAD-14-16-0064

Draft EAD – European Assessment Document EAD-100094-00-0301, rev. yyyy adoptionfinal 20/107
EOTA file № 14-16-0064-03.01

No	Essential characteristic	Assessment method	Type of expression of product performance (level, class, description)
1	Resistance to static load	Static load test (Annex C.1.1) Clause 2.2.1	Level
2	Resistance to fatigue	Fatigue test (Annex C.2) Clause 2.2.2	Level
3	Load transfer to structure	Load transfer test (C.3) Clause 2.2.3	Level
4	Friction coefficient	(1) Tension: - Assessment of - Assembly/ installation/ stressing test (Annex C.5.1) (2) Anchorage / coupling: - Assessment Clause 2.2.4	Level
6	Deviation/ deflection (level) for internal bonded and internal unbonded tendon	- Assessment Clause 2.2.5	Description



Outline: EAD 16 vs. ETAG0 13

- 1) Scope
- 2) Testing program / Series of sizes**
- 3) Test details

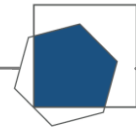

2) Testing program - Series of sizes

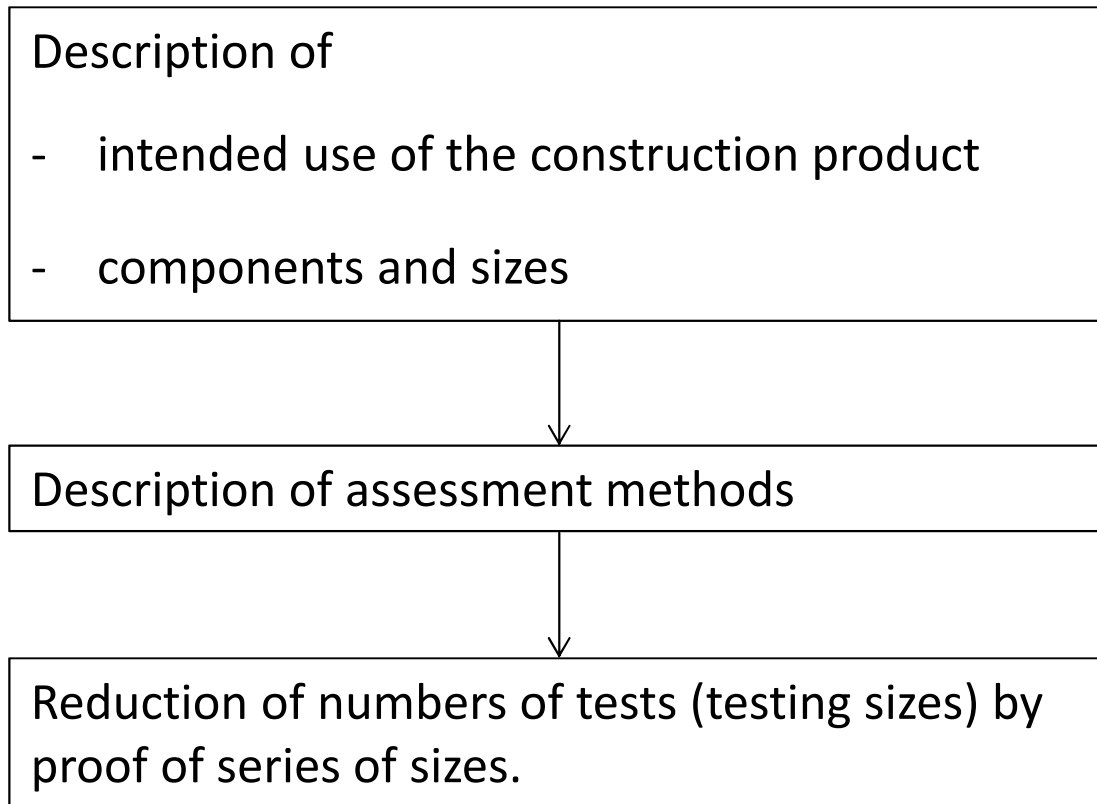

The testing program is the fundament of the assessment process and needs to be agreed with the TAB!



2) Definition of series of sizes

1.3.39 Definition of **series of sizes**

A specific model of an anchorage, coupling, duct, or tendon, etc. which typically is made in several sizes, using the

- same design concept
- same materials
- same corrosion protection system
- and similar geometrical shape

for all sizes form a series.

2.2 Definition of **testing sizes** (Small S, Medium M and Largest L):

Stresses in the components of interpolated sizes shall be not larger than those of the components verified in the test.

Possible reduction of numbers of tests due to similarity of components!

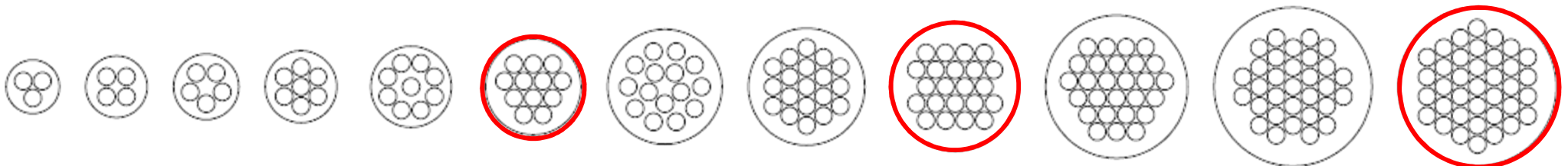



2) Examples of series of sizes - Wedge plate (resistance)

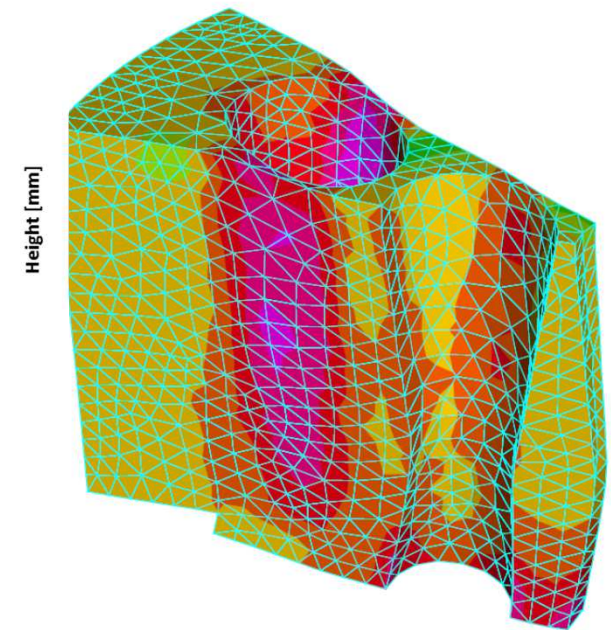
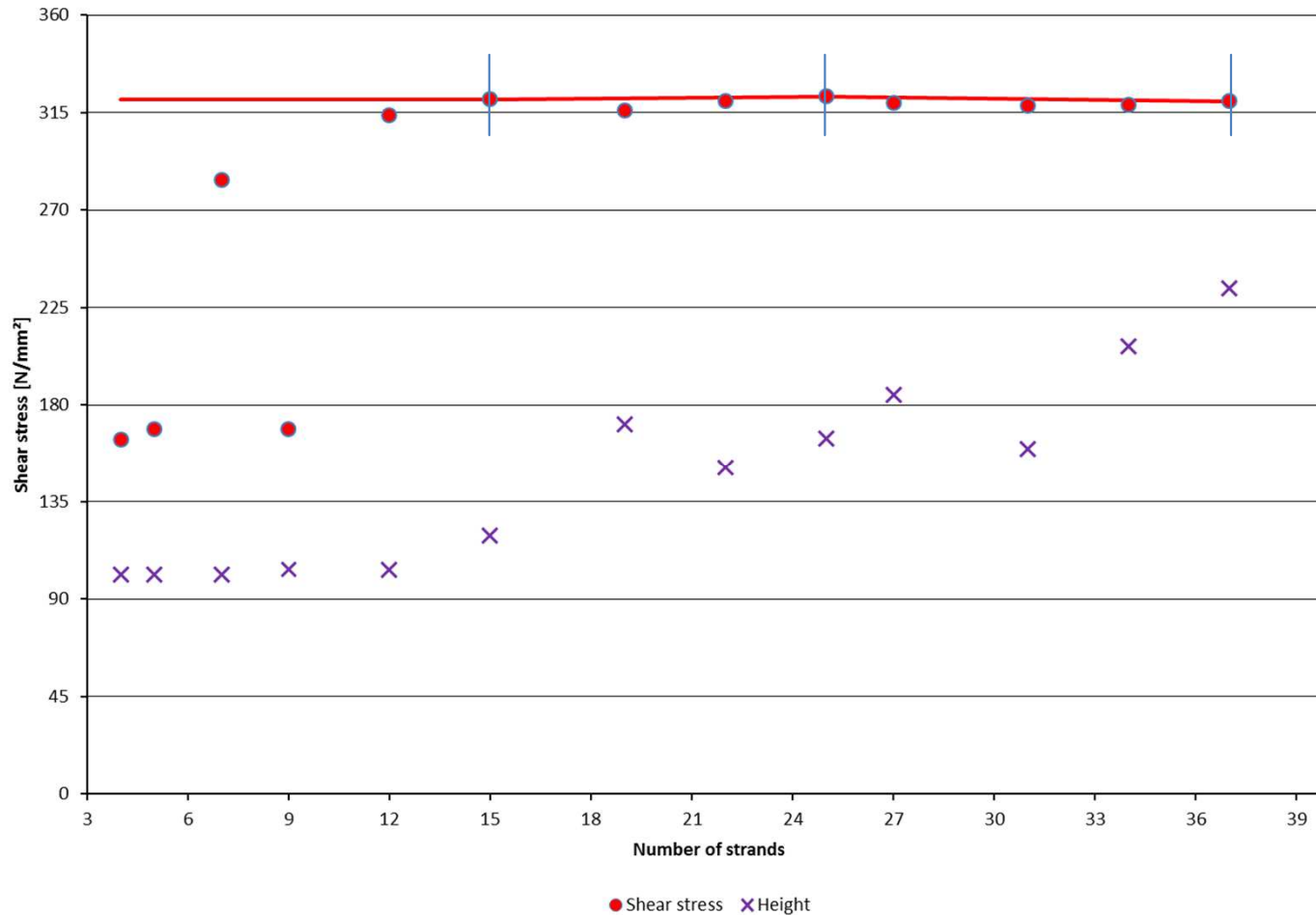

Simple geometrical models are often not sufficient to describe the resistance of the wedge plate due to complexity of loading and material properties!



2) Examples of series of sizes - Anchor zone (resistance)

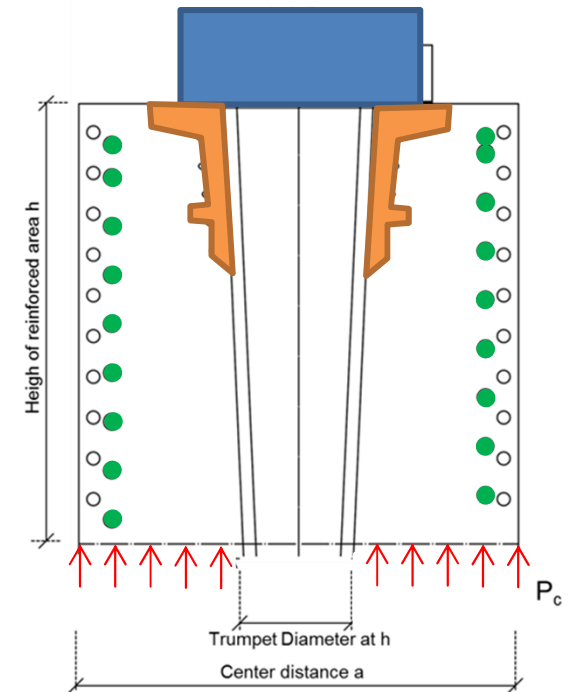
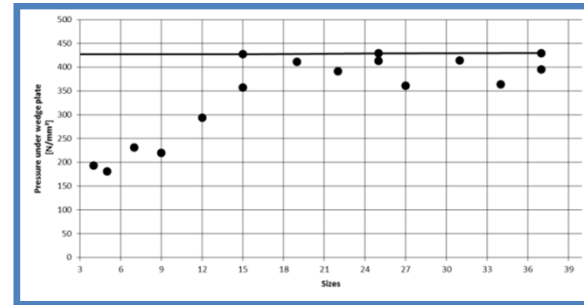
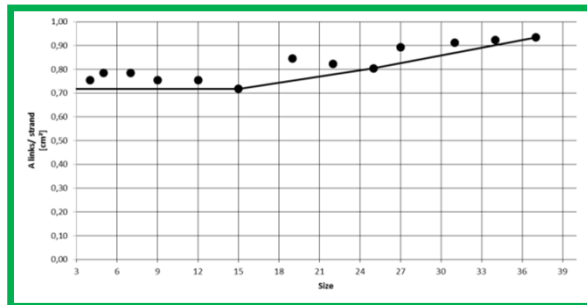
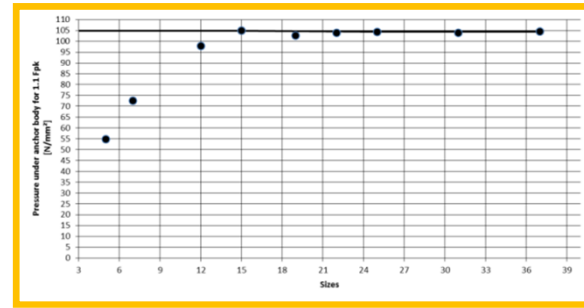
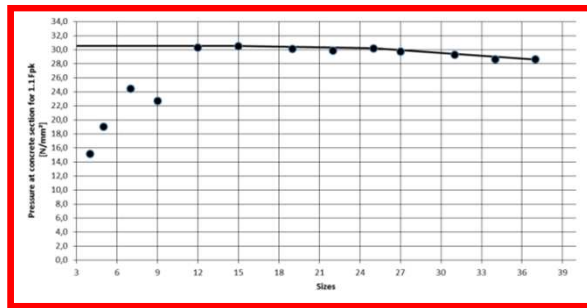

Interaction of all different components (concrete, reinforcement, cast iron trumpet) need to be considered to compare the resistance of the anchor zone!



2) Examples of series of sizes - Deviation (action)

16 strand cable - Is the load always the same?

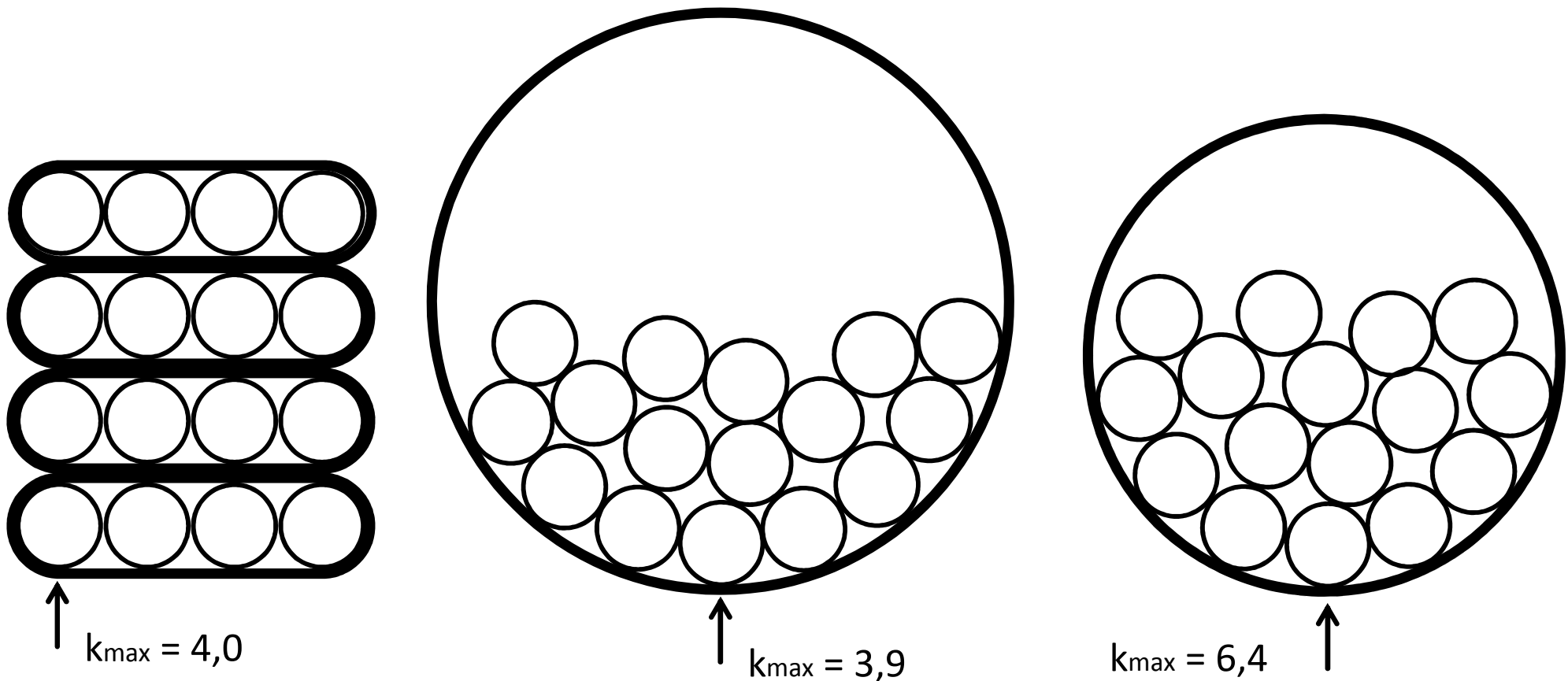

In some cases the models describing the action need to be defined!

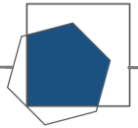

2) Conclusions on testing program - Series of sizes

- No change of main principles of testing program
- Mechanical models need to be applied for series of sizes
- Resistance and action need to be defined properly
- Simple geometrical models are often not sufficient for comparison of components

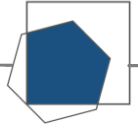

Outline: EAD 16 vs. ETAG 013

- 1) Scope
- 2) Testing program / Series of sizes
- 3) Test details**

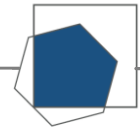

3) Resistance to static load - General

Test assembly

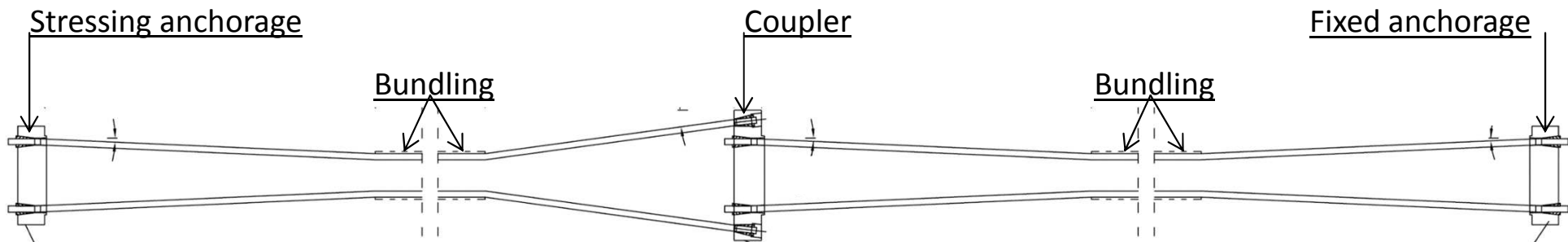

Procedure

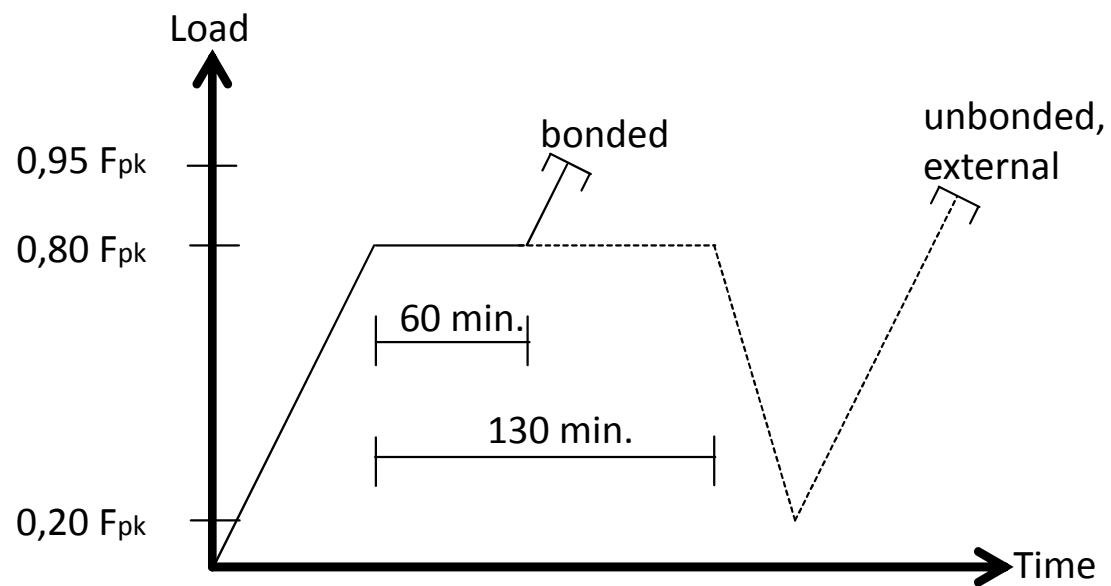



3) Resistance to static load - Number of tests

Number of tests **n = 5**
Number of testing sizes N (S/M/L)

ETAG 013

- N = 3 (2)
- n = 5
- 2 / 1 / 2

- 2 / 0 / 3 (max. 5 sizes)

EAD 16 → $F_{pk} \leq 10.500 \text{ kN}$

- N = 3 (2)
- n = 5
- 2* / 1 / 2 or 1 / 2* / 2

- 2* / 0 / 3 or 0 / 2* / 3 (max. 5 sizes)

* Small/Medium size - higher stressed size needs to be tested (more)

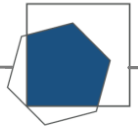

3) Resistance to static load - Number of tests

Number of tests **n = 4**
Number of testing sizes N (S/M/L)

ETAG 013

-

EAD 16 → One size $F_{pk} > 1.500 \text{ kN}$

- N = 2
- n = 4
- 0 / 2* / 2 or 2* / 0 / 2

* Small/Medium size - higher stressed size needs to be tested (more)



3) Resistance to static load - Number of tests

Number of tests $n \geq 5$
Number of testing sizes N (S/M/L)

ETAG 013

-

EAD 16 → $F_{pk} > 10.500$ kN

- $N \geq 3$

- $n \geq 5$

S M1 (M2/...) L

- 1* / 1* / (1*/...) 2

* Small/Medium sizes - higher stressed size needs to be tested 2x

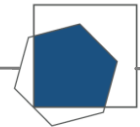

3) Resistance to static load - Evaluation of testing sizes

Number of testing sizes $N = r_2 - r_1 + 1$; $r_1 \geq 2$;

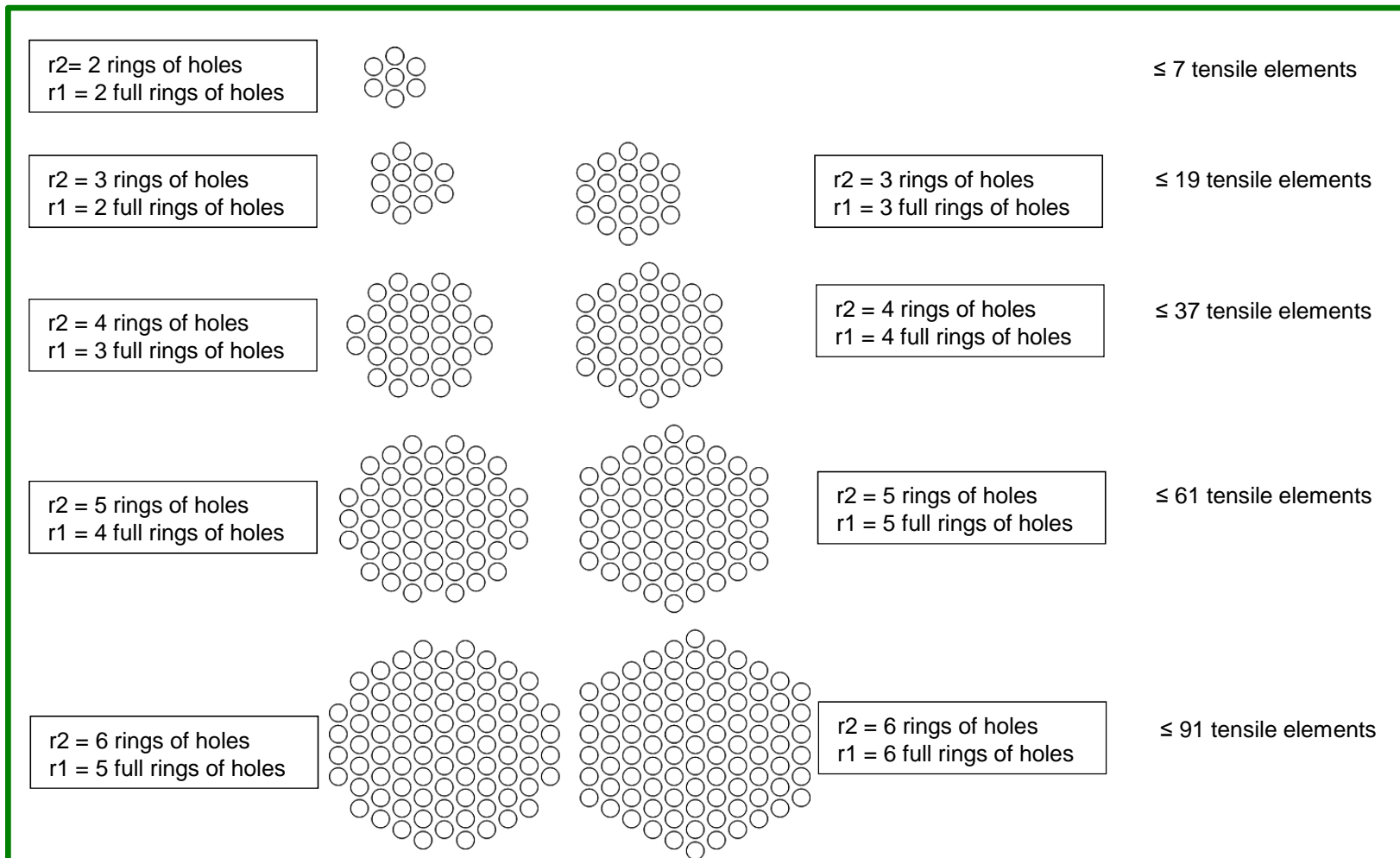

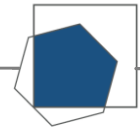

3) Resistance to static load - Examples of number of testing sizes

6-4 to 6-37

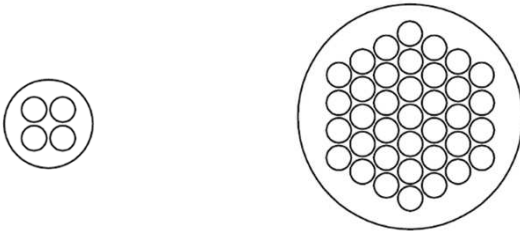

$$F_{pk} = 10.323 \text{ kN} < 10.500 \text{ kN}$$

$$\rightarrow N = 3$$

6-4 to 6-61

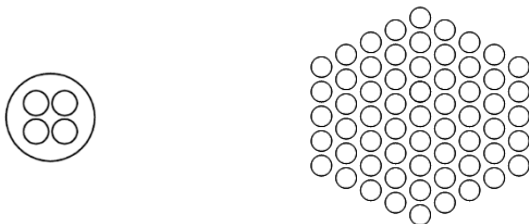

$$F_{pk} = 17.016 \text{ kN} > 10.500 \text{ kN}$$

$$\rightarrow N = 5 - \max(1;2) + 1 = 4$$

$r_2 = 1$

$r_1 = 5$

6-19 to 6-61

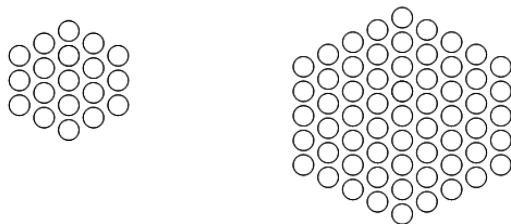

$$F_{pk} = 17.016 \text{ kN} > 10.500 \text{ kN}$$

$$\rightarrow N = 5 - 3 + 1 = 3$$

$r_2 = 3$

$r_1 = 5$

Load range between testing sizes increases!

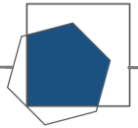

3) Resistance to static load - Bedding in concrete

Anchor head that do not feature a flat contact surface to place in a steel plate may be tested embedded in concrete body.

- LTT – body

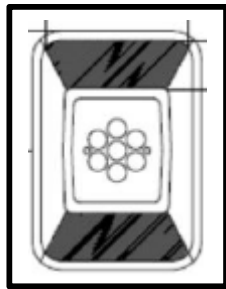

Steel tube

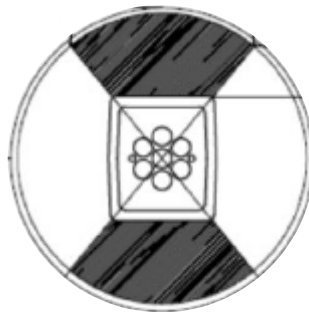

- Concrete strength $f_{cm,e} \leq 1,2 f_{cm,0}$

Comparability of confinement has to be given!

Stiffness:

→ Shape: ring vs. box

→ Cross section: ring vs. reinforcement (Cutting of rings?)

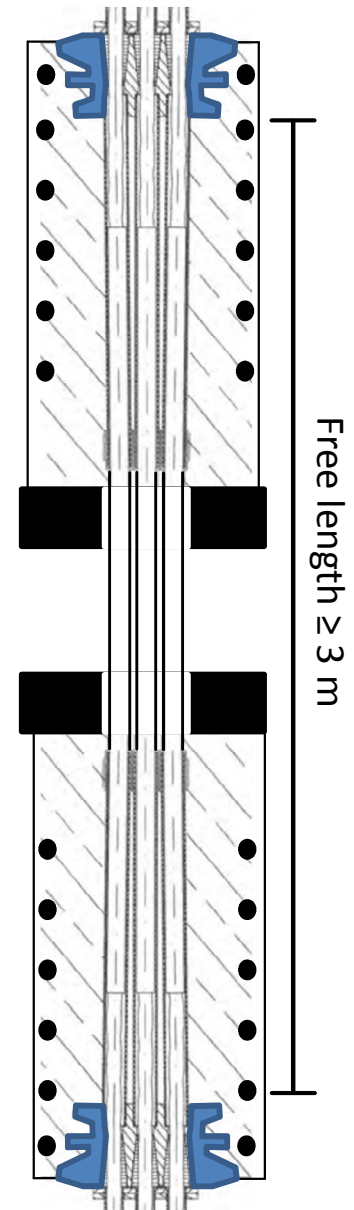



3) Resistance to static load - Topics not considered yet

Additional system requirements, e.g. Lift off tests

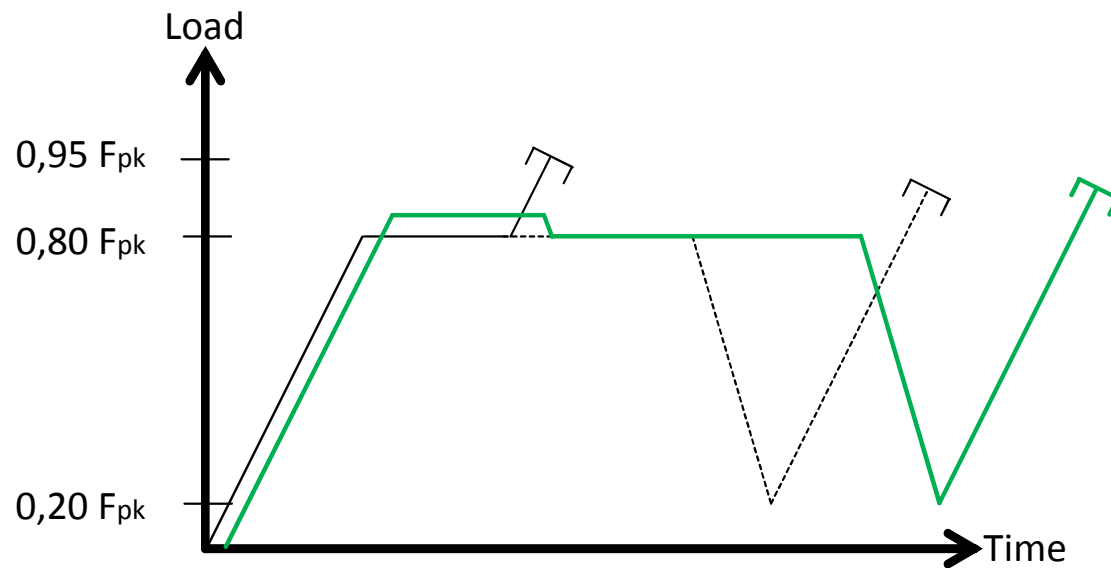
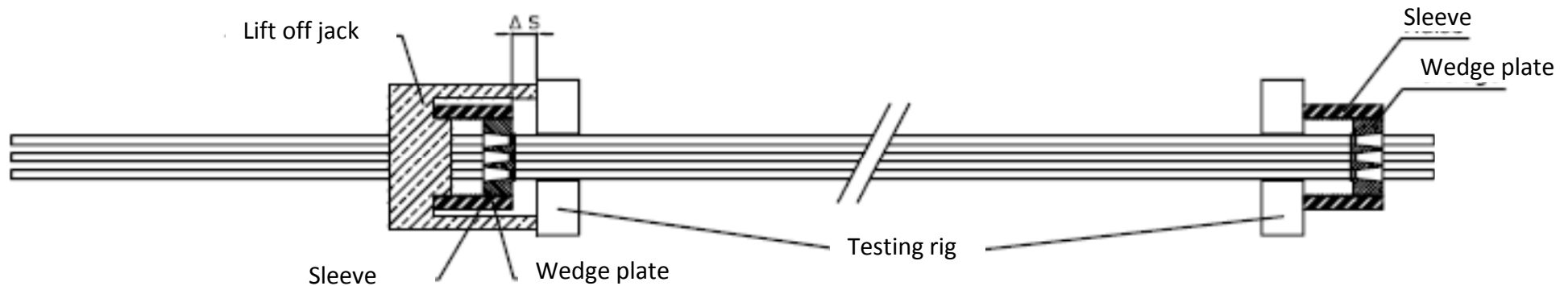

Additional testing requirements might be added to EAD16 regulations.



3) Resistance to static load - Topics not considered yet

Strain measurement of circumferential direction for wedge plates bedded in concrete



Position with most severe stresses need to be chosen!

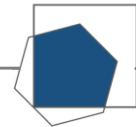

3) Resistance to fatigue - General

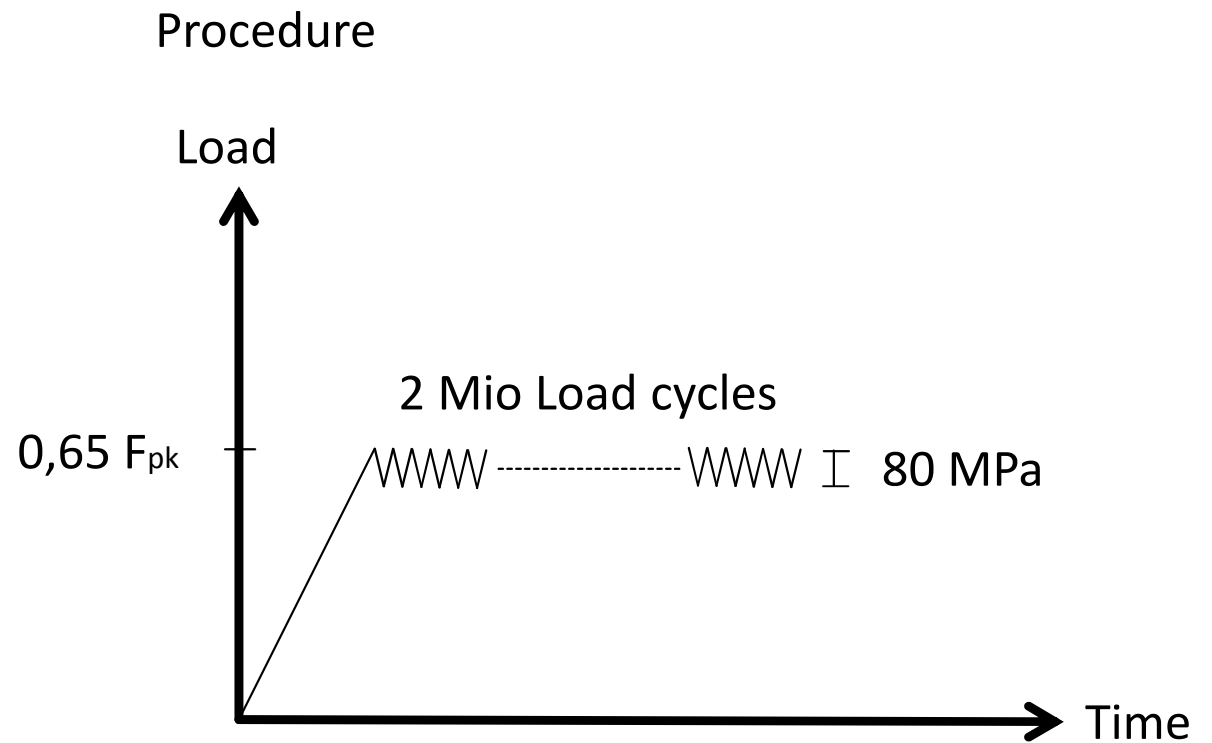



3) Resistance to fatigue - Number of tests

Number of tests **n = 4**
Number of testing sizes N (S/M/L)

ETAG 013

- N = 3(2)
- n = 4
- 1 / 1 / 2

- 1 / 1 / 2 or 1 / 0 / 3 (max. 5 sizes)

EAD 16 → more precisely

- N = 3(2)
- n = 4
- 1 / 1 / 2

- 1 / 1 / 2 or 2* / 0 / 2 or 0 / 2* / 2
(max. 5 sizes)

One size $F_{pk} > 1.500$ kN (wires or strand)

- N = 2
- n = 4
- 0 / 2* / 2 or 2* / 0 / 2

* Small/Medium size - higher stressed size needs to be tested (more)



3) Resistance to fatigue - Testing procedure

Testing frequency

ETAG 013

- ≤ 10 Hz

EAD 16

- ≤ 30 Hz

Higher testing frequency is possible!

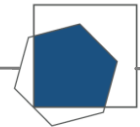

3) Resistance to fatigue - Test assembly

Reduced number of tensile elements

ETAG 013

- If $n \leq 12$: $n' \geq n / 2$
- If $n \geq 12$: $n' \geq 6 + (n - 12)/3$

EAD 16

- If $n \leq 12$: no reduction is allowed
- If $n \geq 12$: $n' \geq \max(12; 6 + (n - 12)/3)$

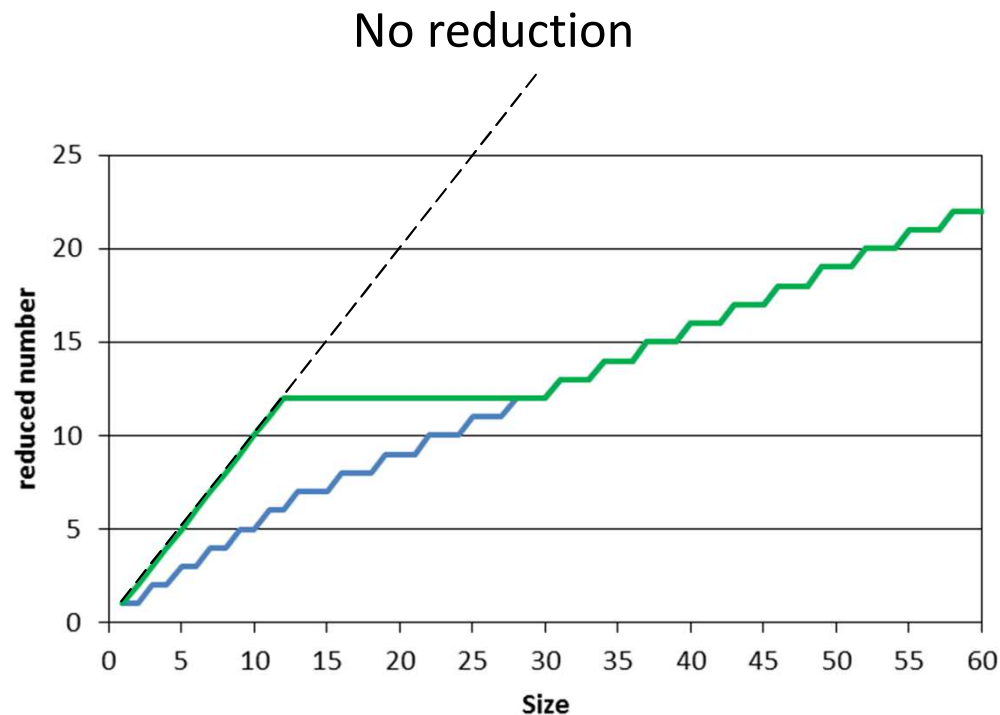



3) Resistance to fatigue - Test assembly

Reduced number of tensile elements - Examples

ETAG 013

- If $n \leq 12$: $n' \geq n / 2$
- If $n \geq 12$: $n' \geq 6 + (n - 12)/3$

EAD 16

- If $n \leq 12$: no reduction is allowed
- If $n \geq 12$: $n' \geq \max(12; 6 + (n - 12)/3)$

Is test representative
for wedge plate?

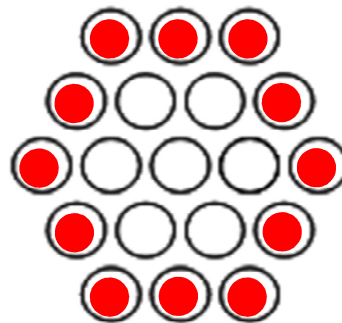

Is test representative for
situation at bundling ring?

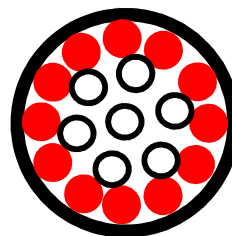



3) Resistance to fatigue - Bond anchorages

Concrete strength of bond anchorages

ETAG 013

- At the start of the fatigue test:
 - $f_{cm,e} \leq f_{cm,0}$

EAD 16 → more precisely

- At the start of the fatigue test:
 - $f_{cm,e} \leq f_{cm,0}$
- At the end of the fatigue test:
 - $f_{cm,e} \leq \min \begin{cases} f_{cm,e} \leq f_{cm,0} + 10 \text{ MPa} \\ f_{cm,e} \leq 1,2 * f_{cm,0} \end{cases}$

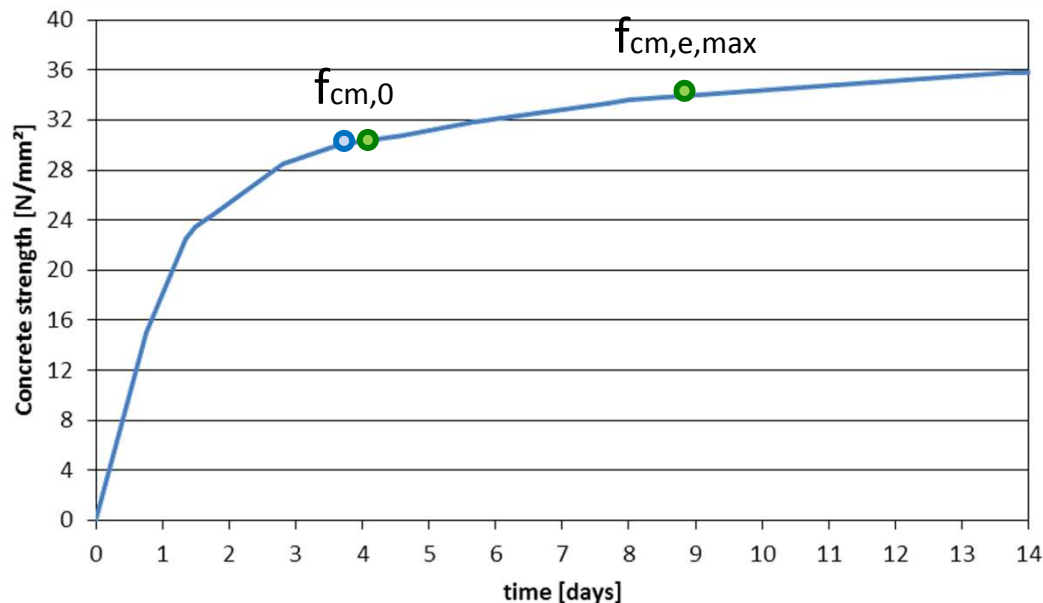

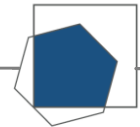

3) Resistance fatigue - Topics not considered yet

Testing of two stages with coupler

- 2 tendons
- 4 anchorages

= **Double the number of potential strand failures (wedge tips, deflections)!**

→ too conservative!

Stage 2

- Losses of cross section $< 5\%$

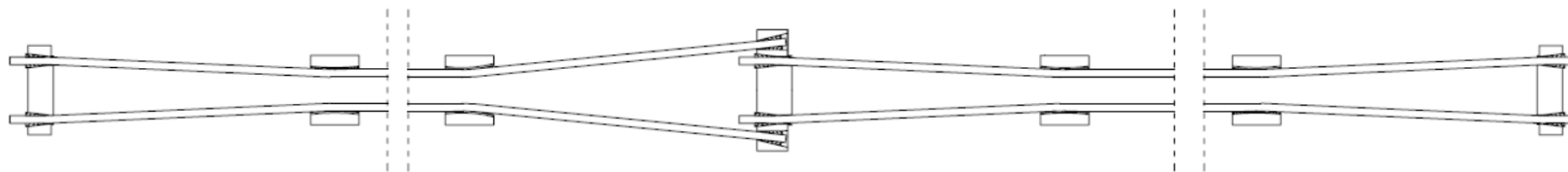

Stage 1

- Losses of cross section $> 5\%$

Both stages

- Losses of cross section $> 5\%$

Could one see each stage as individual test?



3) Load transfer to structure

Test assembly

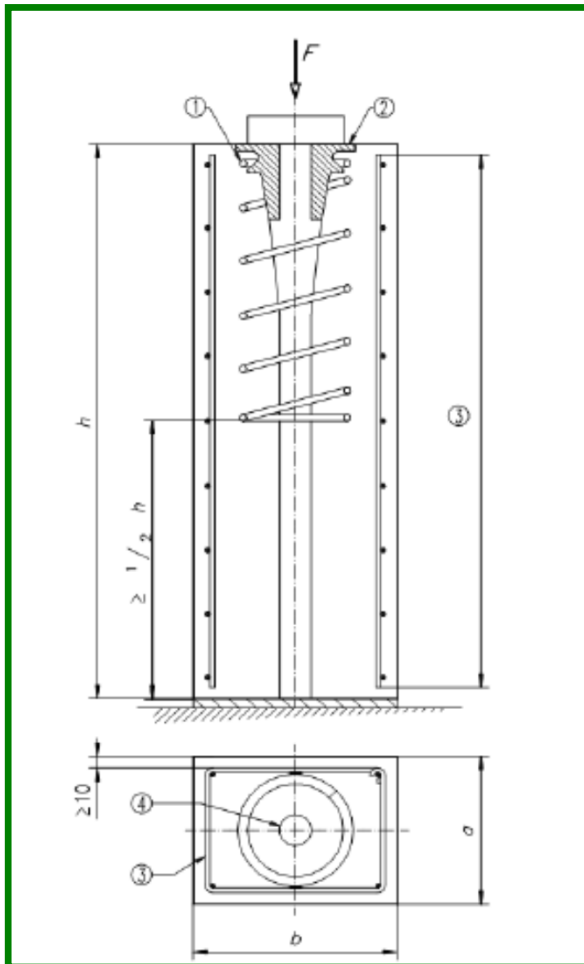

Test procedure

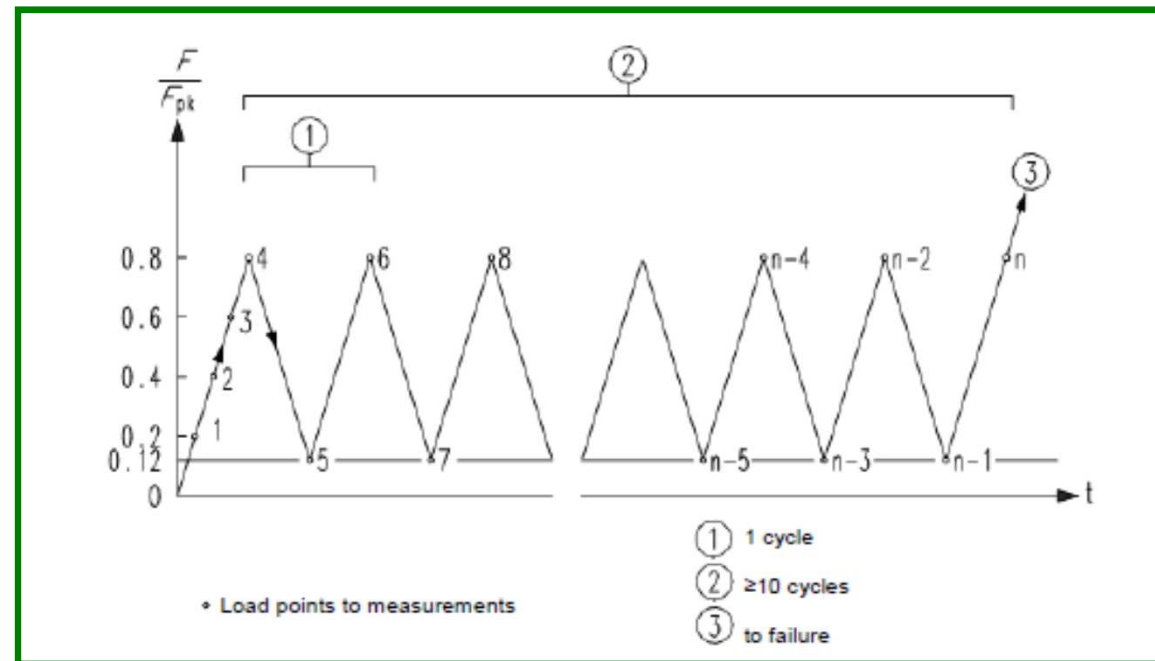



3) Load transfer to structure - Number of tests

Number of tests	n = 4 (for lowest declared concrete strength $f_{cm0,min}$) n = 4 (for the highest declared concrete strength $f_{cm0,max}$) n = 4 (for middle concrete strength if $f_{cm0,max} - f_{cm0,min} > 20$ MPa)
Number of testing sizes	N (S, M, L)

ETAG 013

- N = 3 (2)
- n = 4
- 1 / 1 / 2
- 1 / 0 / 3 (maximum 5 sizes)

EAD 16 → $F_{pk} \leq 10.500$ kN

- N = 3 (2)
- n = 4
- 1 / 1 / 2
- 2* / 0 / 2 or 0 / 2* / 2 (max. 5 sizes)

* Small/Medium size - higher stressed size needs to be tested (more)

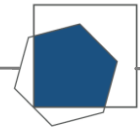

3) Load transfer to structure - Number of tests

Number of tests	n = 4 (for lowest declared concrete strength $f_{cm0,min}$) n = 4 (for the highest declared concrete strength $f_{cm0,max}$) n = 4 (for middle concrete strength if $f_{cm0,max} - f_{cm0,min} > 20$ MPa)
Number of testing sizes	N (S, M, L)

ETAG 013

-

EAD 16 → One size $F_{pk} > 1.500$ kN

- N = 2
- n = 4
- 0 / 2* / 2 or 2* / 0 / 2

* Small/Medium size - higher stressed size needs to be tested (more)

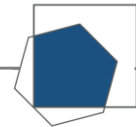

3) Load transfer to structure - Number of tests

Number of tests	$n \geq 4$ (for lowest declared concrete strength $f_{cm0,min}$) $n \geq 4$ (for the highest declared concrete strength $f_{cm0,max}$) $n \geq 4$ (for middle concrete strength if $f_{cm0,max} - f_{cm0,min} > 20$ MPa)
Number of testing sizes	N (S, M, L)

ETAG 013

-

EAD 16 → $F_{pk} > 10.500$ kN

- $N \geq 3$
- $n \geq 4$

S M1 (M2/...) L

- 1 / 1 / (1/...) 2



3) Load transfer to structure - Number of tests

Number of tests	n = 3 (for lowest declared concrete strength $f_{cm0,min}$) n = 3 (for the highest declared concrete strength $f_{cm0,max}$) n = 3 (for middle concrete strength if $f_{cm0,max} - f_{cm0,min} > 20$ MPa)
Number of testing sizes	N (L)

ETAG 013

-

EAD 16 → Only one anchorage size

- N = 1
- n = 3



3) Load transfer to structure - Mechanical anchorages

ETAG 013

Mechanical anchorages

- Bursting reinforcement
 - longitudinal bars $\leq 0,003 A_c$
 - uniformly distributed stirrups $\leq 50 \text{ kg/m}^3$
-
- $F_u \geq 1,1 F_{pk} (f_{cm,e} / f_{cm,0})$

EAD 16

Mechanical anchorages

- Bursting reinforcement
 - longitudinal bars $\leq 0,003 A_c$
 - uniformly distributed stirrups $\leq 50 \text{ kg/m}^3$ *
-
- $F_u \geq 1,1 F_{pk} (f_{cm,e} / f_{cm,0})$

* Combination with bursting reinforcement is possible



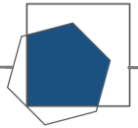

3) Load transfer to structure - Anchorages with brittle behavior

ETAG 013

Anchorages with brittle behavior

- not defined

EAD 16

Anchorages with brittle behavior*

- longitudinal bars $\leq 0,003 A_c$
- uniformly distributed stirrups $\leq 50 \text{ kg/m}^3$
- $F_u \geq 1,3 F_{pk} (f_{cm,e} / f_{cm,0})$

* 50 kg/m^3 reinforcement is mandatory for structure!

No regulations regarding distribution of 50 kg/m^3 in the structure! Is it confining?

Unreinforced structure is not covered!

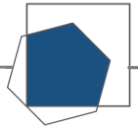

3) Load transfer to structure - Concrete strength

ETAG 013

Concrete strength

- $f_{cm,e} \leq f_{cm,0}$

EAD 16

Concrete compressive strength

- $f_{cm,e} \leq f_{cm,0} + 3 \text{ MPa}$



3) Load transfer to structure - Test specimen

ETAG 013

- $A_c = x * y = a * b$
- $x \geq 0,85 a$
- $y \leq 1,15 b$

EAD 16

- $A_c = x * y \geq a * b$
- $x \geq 0,85 a$
- $y \geq 0,85 b$

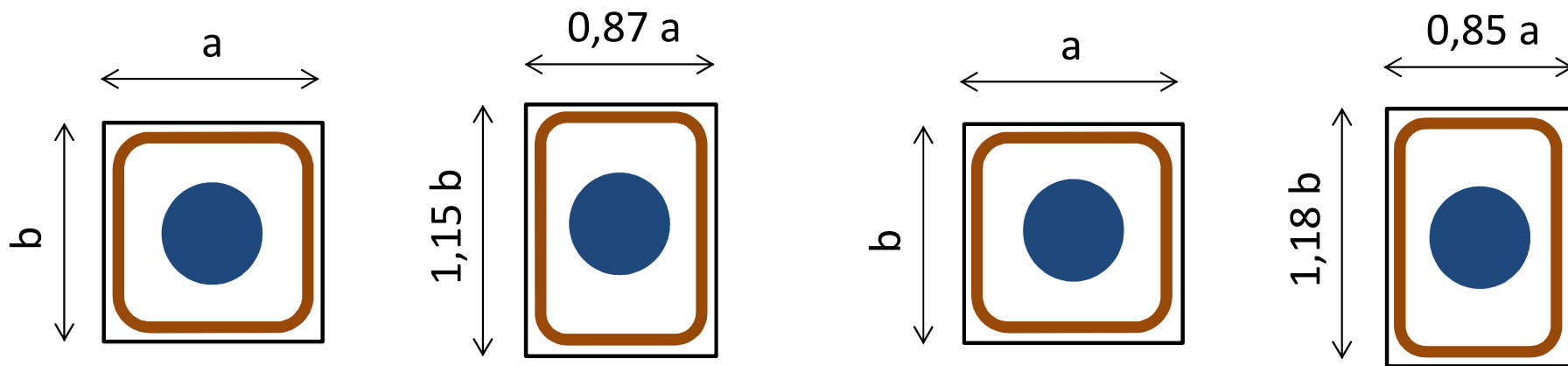

Is the mechanical behavior comparable (\rightarrow confinement, Capacity < 110%)?



3) Load transfer to structure - Crack width

ETAG 013

-

EAD 16 → more precisely

- Stabilization criterion for crack width shall, however only apply for cracks widths larger than 0,1 mm

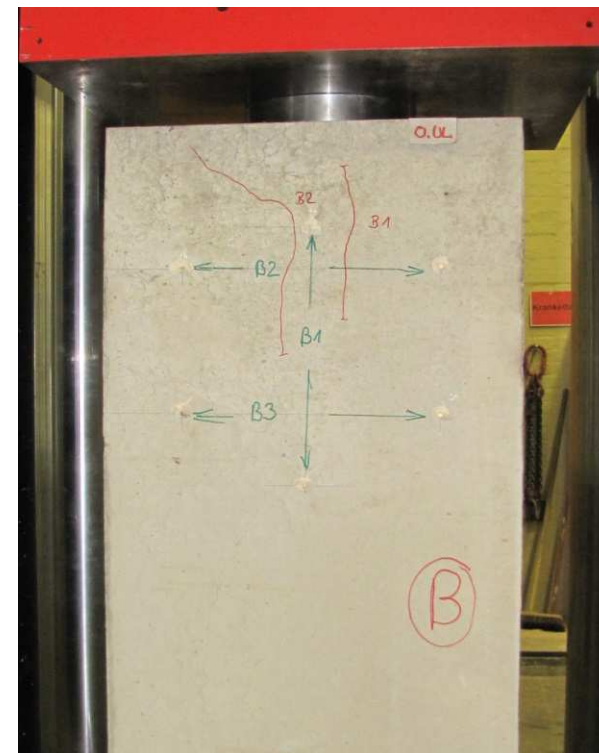

Cracks $< 0,1$ mm should be measured although because they can grow $> 0,1$ mm.

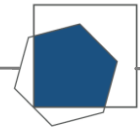

3) Load transfer to structure - Bond anchorage

ETAG 013

- Bond anchorages
 - $F_u \geq 1,1 F_{pk} (f_{cm,e} / f_{cm,0})$
 - $f_{cm,e} \leq 80 \% f_{cm,0}$

EAD 16 → more precisely

- Bond anchorages
 - $F_u \geq 1,1 F_{pk} (f_{cm,e} / f_{cm,0})$
 - $f_{cm,e} \leq 80 \% f_{cm,0}$

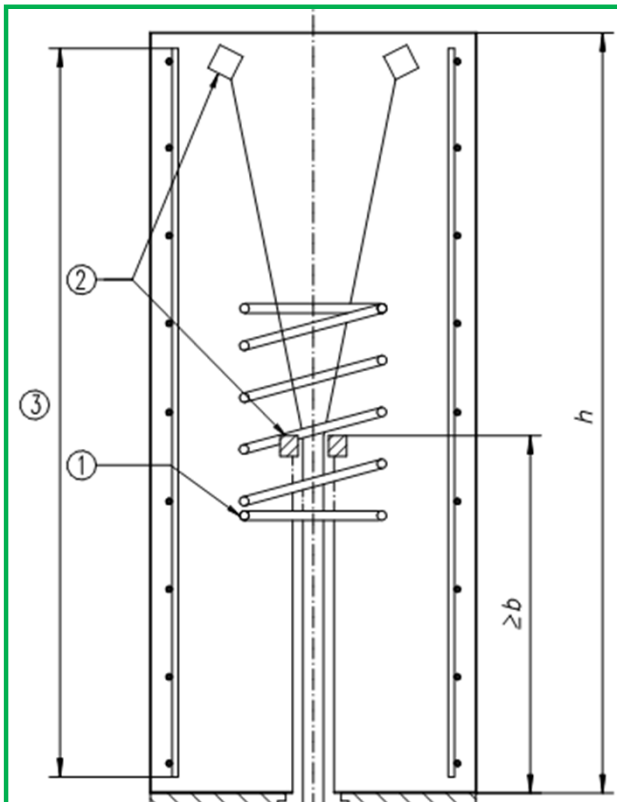

Second test if ultimate load force but no stabilization was reached

- Maximum load level 80 % F_{pk}
- Concrete strength $f_{cm,e} \leq f_{cm,0}$
- No need to test to failure

Dimensions

- *The test specimen may have a larger cross section to compensate the lower concrete strength $f_{cm,e} \leq 80 \% f_{cm,0}$*





3) Load transfer to structures - Topics not considered yet

Bursting stresses at strand deviation

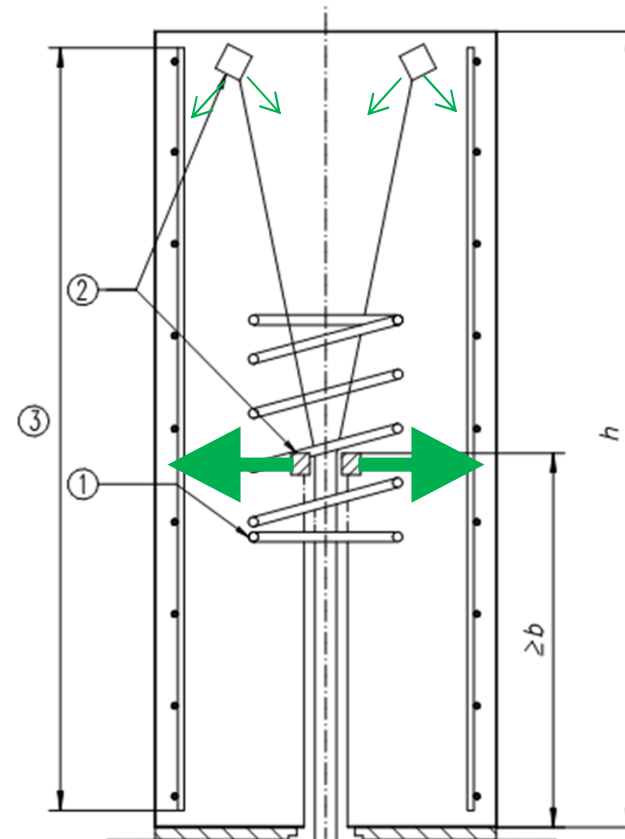
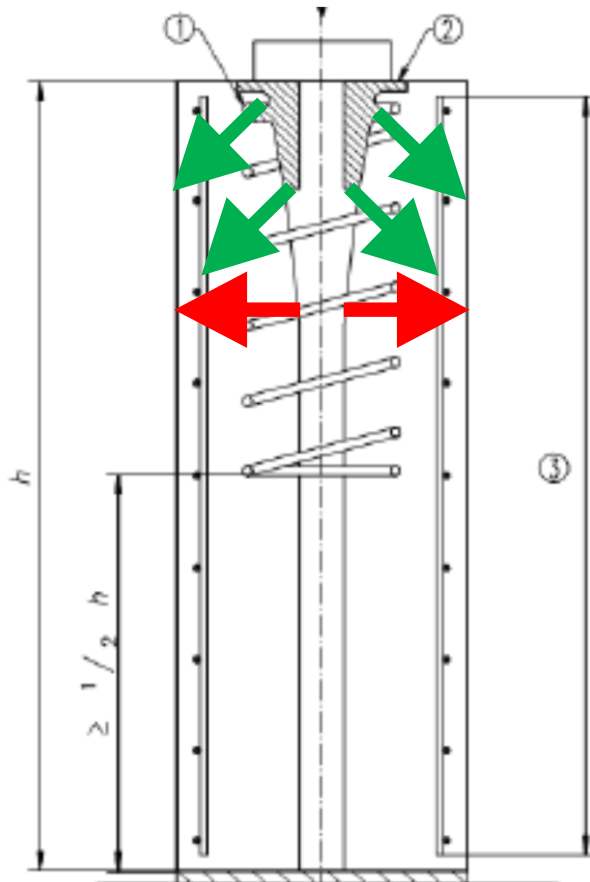

Bursting stresses at strand bundling are not covered by loading from the top without tendon!

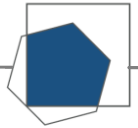

3) Deviation and deflection limits

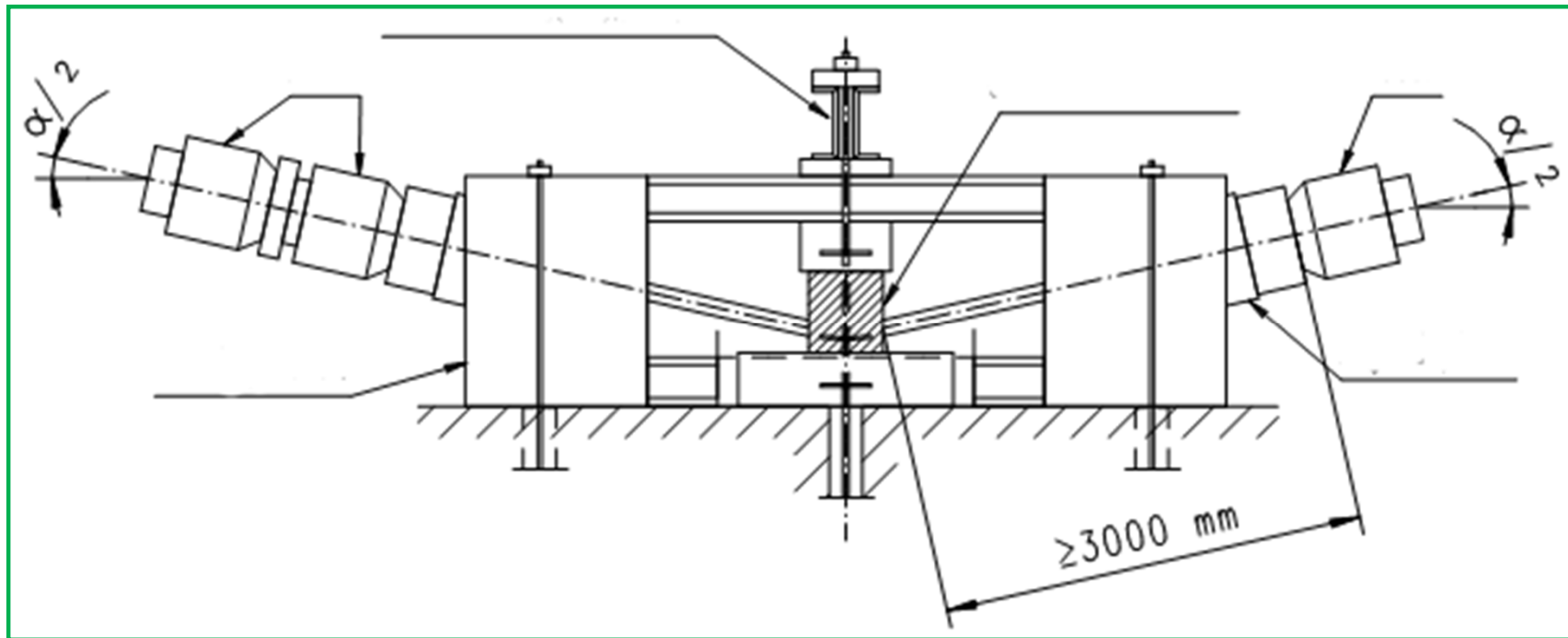



3) Deviation and deflection limits



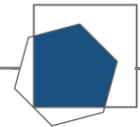

3) Deviation and deflection limits - General

	Limiting Factors	Fretting	Bending	Wear	Torsion
Bonded	Steel duct	X	X	-	-
	PE-duct	X	X	X	X
Unbonded	Steel duct	-*	X	-	-
	PE-duct	-*	X	X	X

Fretting: fatigue of prestressed steel in contact with steel under transverse load

Bending: limited strain of external fibres when bent

Wear: imprint of steel in soft plastic duct

Torsion: Rupture of strands under service load by additional torsion near anchorage
(only for plastic duct, only for strands, only at stressing anchorage, only for relative movement between strand and duct)

* Cyclic range of stresses is negligible

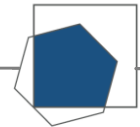

3) Deviation and deflection limits - Fretting

	Limiting Factors	Fretting	Bending	Wear	Torsion
Bonded	Steel duct	X	X	-	-
	PE-duct	X	X	X	X
Unbonded	Steel duct	-*	X	-	-
	PE-duct	-*	X	X	X

- National regulations
- EAD Formula
- Tests (Beam fatigue tests)

$$R_{min} = \frac{2 \cdot F_{pm0} \cdot d_{strand}}{p_{R,max} \cdot d_{duct,i}} \geq 2.5 \text{ m}$$

$$p_{R,max} = 130, 150 \text{ or } 200 \text{ kN/m}$$

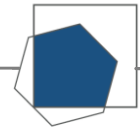

3) Deviation and deflection limits - Bending

	Limiting Factors	Fretting	Bending	Wear	Torsion
Bonded	Steel duct	X	X	-	-
	PE-duct	X	X	X	X
Unbonded	Steel duct	-*	X	-	-
	PE-duct	-*	X	X	X

- National regulations
- Proposed values
- Tests (Deviator static load test)

UnitsTendons with strands	Minimum radius of curvature at deviator
19 ϕ 13 mm or 12 ϕ 15 mm	2,5 m
31 ϕ 13 mm or 19 ϕ 15 mm	3,0 m
55 ϕ 13 mm or 37 ϕ 15 mm	4,0 m
61 ϕ 15 mm	5,5 m

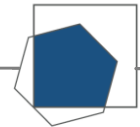

3) Deviation and deflection limits - Wear

	Limiting Factors	Fretting	Bending	Wear	Torsion
Bonded	Steel duct	X	X	-	-
	PE-duct	X	X	X	X
Unbonded	Steel duct	-*	X	-	-
	PE-duct	-*	X	X	X

- **Wear resistance according to fib Bulletin 75 (bonded)**
- **Deviated tendon test (unbonded)**

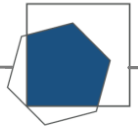

3) Deviation and deflection limits - Torsion of strands

	Limiting Factors	Fretting	Bending	Wear	Torsion
Bonded	Steel duct	X	X	-	-
	PE-duct	X	X	X	X
Unbonded	Steel duct	-*	X	-	-
	PE-duct	-*	X	X	X

- **Not covered by ETAG 013 or EAD 16 → safety risk**
- *Deviated static load test with deviation near anchorage*
- *Minimum 3 m straight length*





3) Deviation and deflection limits - Examples

19 strand tendon

prestressing concrete
(general / state of the art)

pt system
(specific technology)

	Limiting Factors	Fretting	Bending	Wear	Torsion
Bonded	Steel duct	8,7	3,0	-	-
	PE-duct	7,8	3,0	5,5	7,0
Unbonded	Steel duct	-	3,0	-	-
	PE-duct	-	3,0	4,0	7,0
		Formula	Table	Test	(Test)

choose maximum
as R_{min}

Applies only for
stressing anchorage



3) Deviation and deflection limits - Deviated tendon test

Residual wall thickness

ETAG 013

- Residual wall thickness of duct wall or sheathing
 - $\geq 50\%$ of initial wall thickness
 - $\geq 0,8$ mm
- Residual sheathing of monostrand after restressing
 - $\geq 50\%$ of initial wall thickness
 - $\geq 1,0$ mm
- Residual wall thickness of duct after restressing
 - $\geq 75\%$ of initial wall thickness
 - $\geq 2,0$ mm

EAD 16

- Residual wall thickness of duct wall or sheathing
 - $\geq 50\%$ of initial wall thickness
 - $\geq 0,8$ mm
- Residual sheathing of monostrand after restressing → **not included**
- Residual wall thickness of duct after restressing → **not included**



3) Deviated tendon test - Topics not considered yet

Measurement of duct initial wall thickness

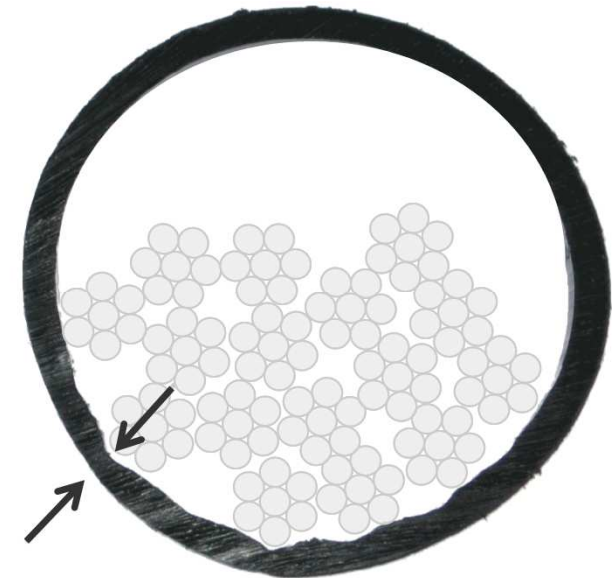
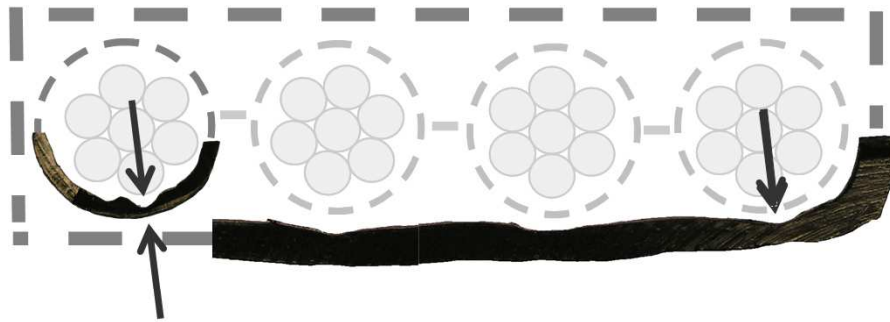

Production process of duct has to be considered choosing a proper position for initial wall thickness!

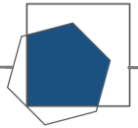

3) Resistance to static load under cryogenic conditions

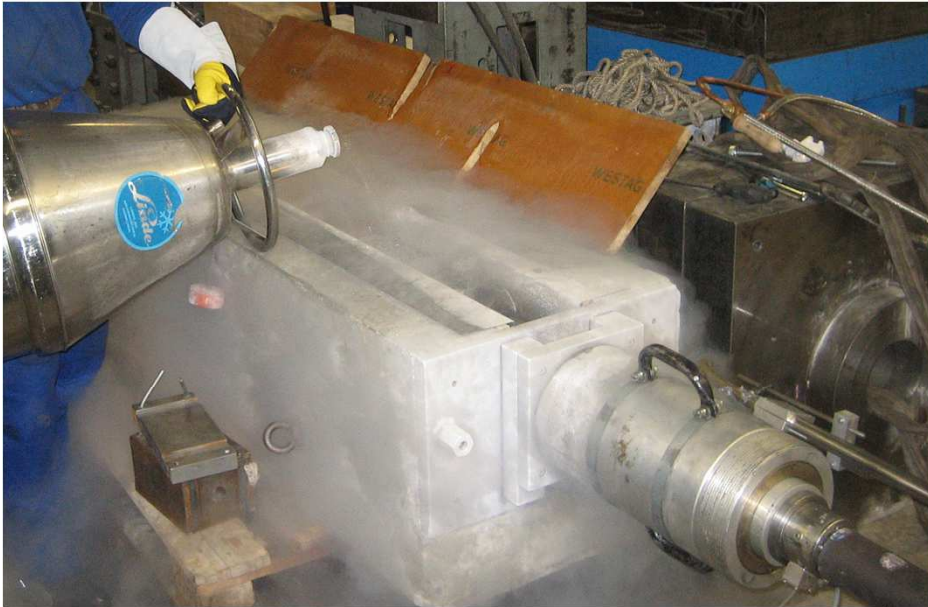



3) Resistance to static load under cryogenic conditions - Test procedure

ETAG 013

EAD 16

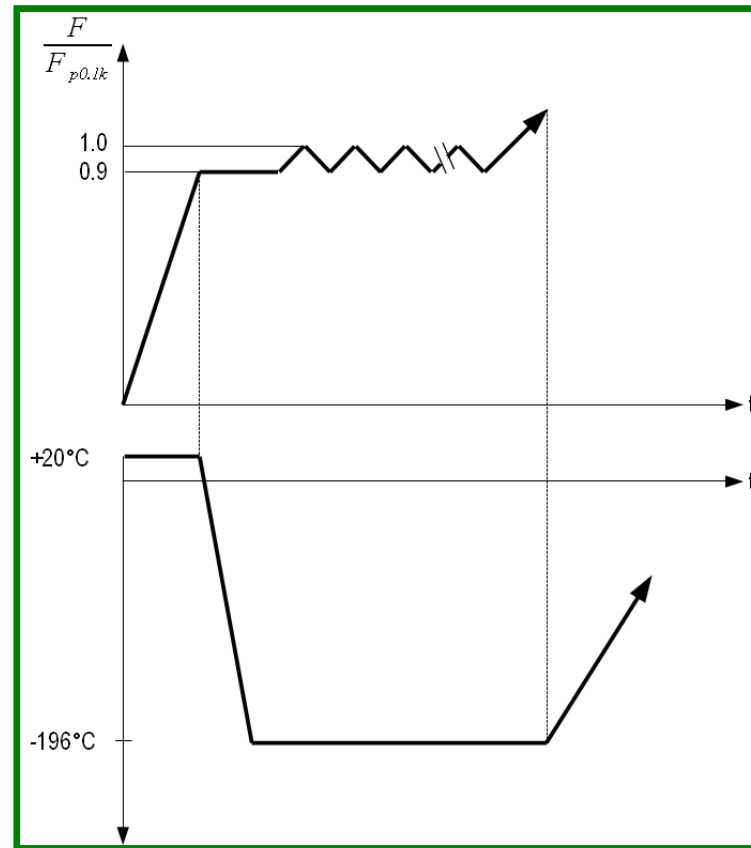
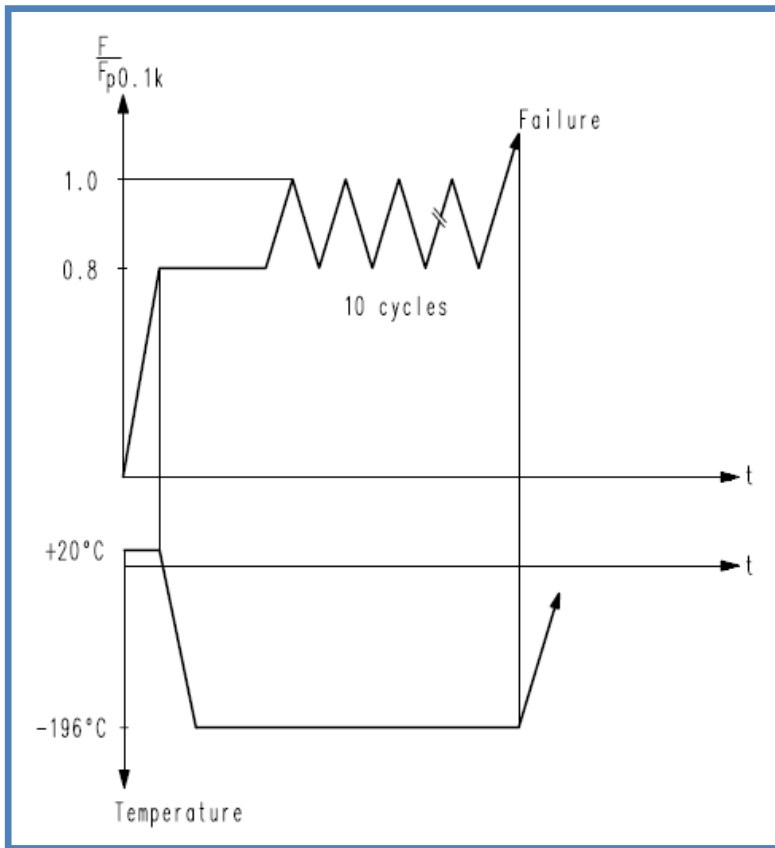



3) Resistance to static load under cryogenic conditions - Numbers of tests

Anchorage outside the possible cryogenic zone

ETAG 013

-

EAD 16

- 3 single strand tests under cryogenic conditions



3) Resistance to static load under cryogenic conditions - Numbers of tests

Anchorage inside the possible cryogenic zone

ETAG 013

-

EAD 16

- Single strand tests
- Number of tests: 3

ETAG 013

- Bundle test
- Number of tests: 1
- Testing size: largest tendon size as permitted by available testing facilities shall be tested

EAD 16

- Bundle test
- Number of tests: 1*
- Testing size: medium size with at least 60 % F_{pk} of the specified characteristic strength of the largest size of the series

* With either one or both end anchorages subjected to cryogenic conditions. This depends on application.



3) Resistance to static load under cryogenic conditions - Acceptance criteria

No anchorage or only one anchorage under cryogenic conditions

ETAG 013

- $F_{\max} \geq 0,95 * F_{pm}$ (at room temperature)
- $F_{\max} \geq 0,95 * F_{pk}$ (at room temperature)
- Total elongation ϵ_{Tu} at maximum load shall be declared
- Loading to failure

EAD 16

- $F_{\max} \geq 0,95 * F_{pm}$ (at room temperature)
- $F_{\max} \geq 0,95 * F_{pk}$ (at room temperature)
- Total elongation $\epsilon_{Tu} \geq 2 \%$ at maximum load
- Test may be stopped once 2 % elongation has been reached



3) Resistance to static load under cryogenic conditions - Acceptance criteria

Both anchorages under cryogenic conditions

ETAG 013

- $F_{\max} \geq 0,95 * F_{pm}$ (at room temperature)
- $F_{\max} \geq 0,95 * F_{pk}$ (at room temperature)
- Total elongation ϵ_{Tu} at maximum load shall be declared
- Loading to failure

EAD 16

- $F_{\max} \geq F_{p0,1,cryo}$
- Test may be terminated when $F_{p0,1,cryo}$ is attained

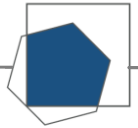

3) Resistance to static load under cryogenic conditions - Topics not considered yet

Measurement of temperature under cryogenic conditions / stabilization of temperature



Proper stabilization criteria (e.g. waiting for a specific time, etc.) for temperature of tendon is not given!



3) Others (not mentioned)

Friction Coefficient

- EAD 16: Chapter 2.2.4

Practicability / Reliability

- EAD 16: Chapter 2.2.7

Plastic ducts

- EAD 16: Chapter 2.2.10 – 2.2.12
- fib recommendation Bulletin 75

Corrosion protection

- EAD 16: Chapter 2.2.13

Monostrand

- EAD 16: Chapter 2.2.14 – 2.2.34

Special filling material

- EAD DP 15-16-0027-0301

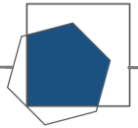

3) Conclusions

- No major changes of main principles of testing
- Number of tests similar, but determined more precisely
- Acceptance criteria of tests similar, but determined more precisely
- Some characteristics need to be described more precisely, e.g. deviation

No revolution → evolution
Improvement with minor deficiencies

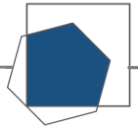

EAD 16 vs. ETAG 013: technical modifications and lessons learned

Jürgen Schulz

schulz@matrics-engineering.com

+49 89 890 65 98 -04

Dr. Hermann Weiher

weiher@matrics-engineering.com

+49 89 890 65 98 -06

matrics engineering GmbH, Nymphenburger Str. 20a, 80335 Munich, Germany